

## Description

LPK is a range of compact in line duct fans. They benefit from very low profiles. The LPK 200 is only 20 mm higher than the duct diameter. This makes the LPK range an ideal choice where a low installed height is required. All fans are fitted with an external rotor motor whose bearings are sealed for life and a forward curved impeller for high performance and a very low sound level. Cleaning and maintenance are made easy with the swing out motor and impeller assembly.



## Technical data

Parameter	Value	Unit
Voltage	230	V
Phase	1	~
Frequency	50	Hz
Power	0.18	kW
Current	0.77	A
R.p.m.	1100	r/m
Max. temperature of transported air	60	°C
Max. temperature of transported air when speed-controlled	60	°C
Sound pressure level at 3 m	50	dB(A)
Length	512	mm
Width	402	mm
Height	220	mm
Weight	5.2	kg
Enclosure class, motor	44	IP
Insulation class, motor	F	
Capacitor	6	µF
Duct connection	ø200 mm	

Diagrams

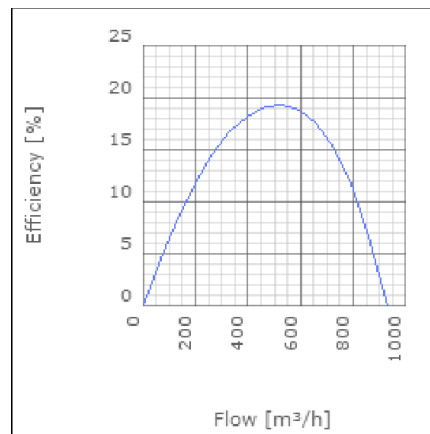
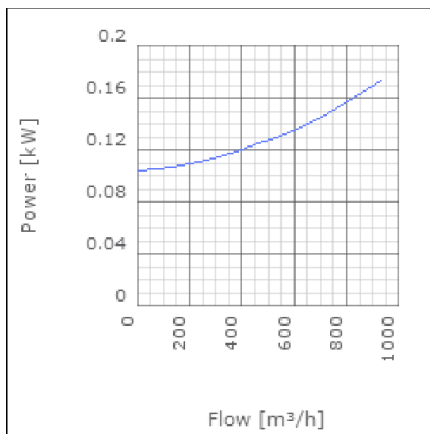
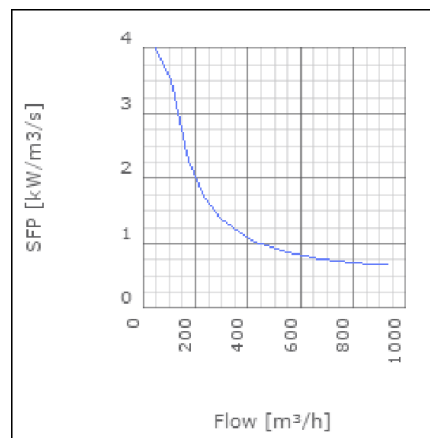
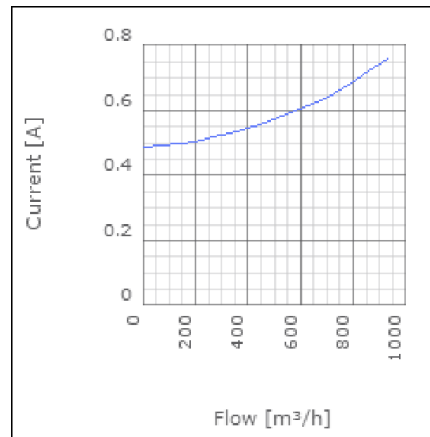
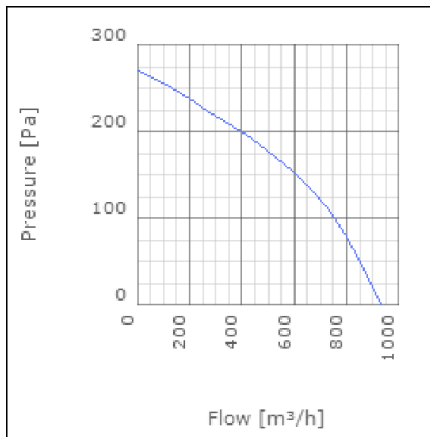

Sound

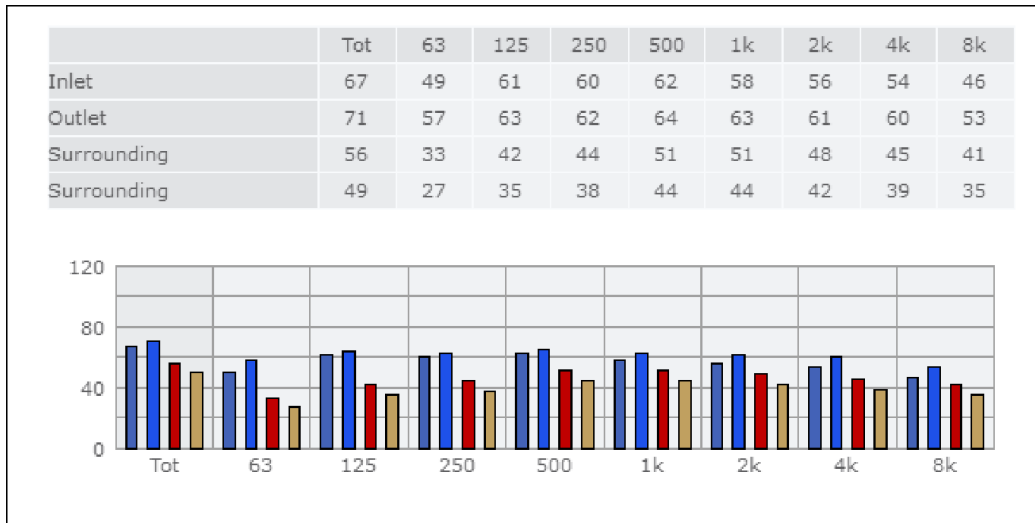

**Parameter**

Distance: 3.000  
 Propagation type: Hemi-spherical  
 Equivalent absorption area: 20.00

**Checked point**

Flow 433.094m<sup>3</sup>/h  
 Static pressure 192Pa

**Working point**

Flow 433.771m<sup>3</sup>/h  
 Static Pressure 193Pa  
 Power 0.12kW  
 Speed 0r/m  
 Current 0.56A  
 Voltage 230V  
 Efficiency 18.873%  
 SFP 0kW/m<sup>3</sup>/s

## Dimensions

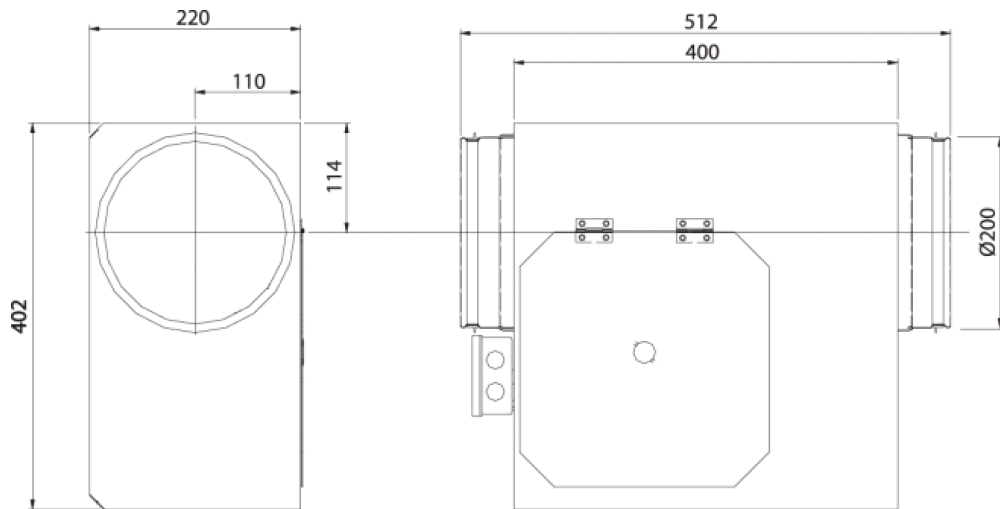

## Wiring diagram

4040001

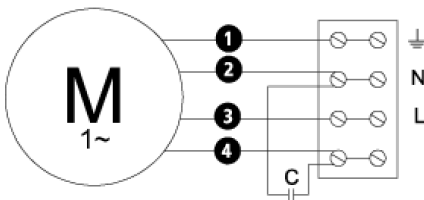

- (M) = Fan Motor
- (M1) = Fan Motor
- (M2) = Fan Motor
- (M3) = Rotor Motor
- 1 = Yellow/Green
- 2 = Black
- 3 = Blue
- 4 = Brown
- 5 = White (TW)
- 6 = Orange
- 7 = Grey
- 8 = Red
- 9 = Green
- 10 = Violet

## Accessories

- ETFV-94A
- FRE 6
- VRDE 1,5
- VRS 1,0
- VRTEC

## Electrical accessories

- FLF 200
- FLK 200
- BSV 200
- YG 200
- LDC 200